

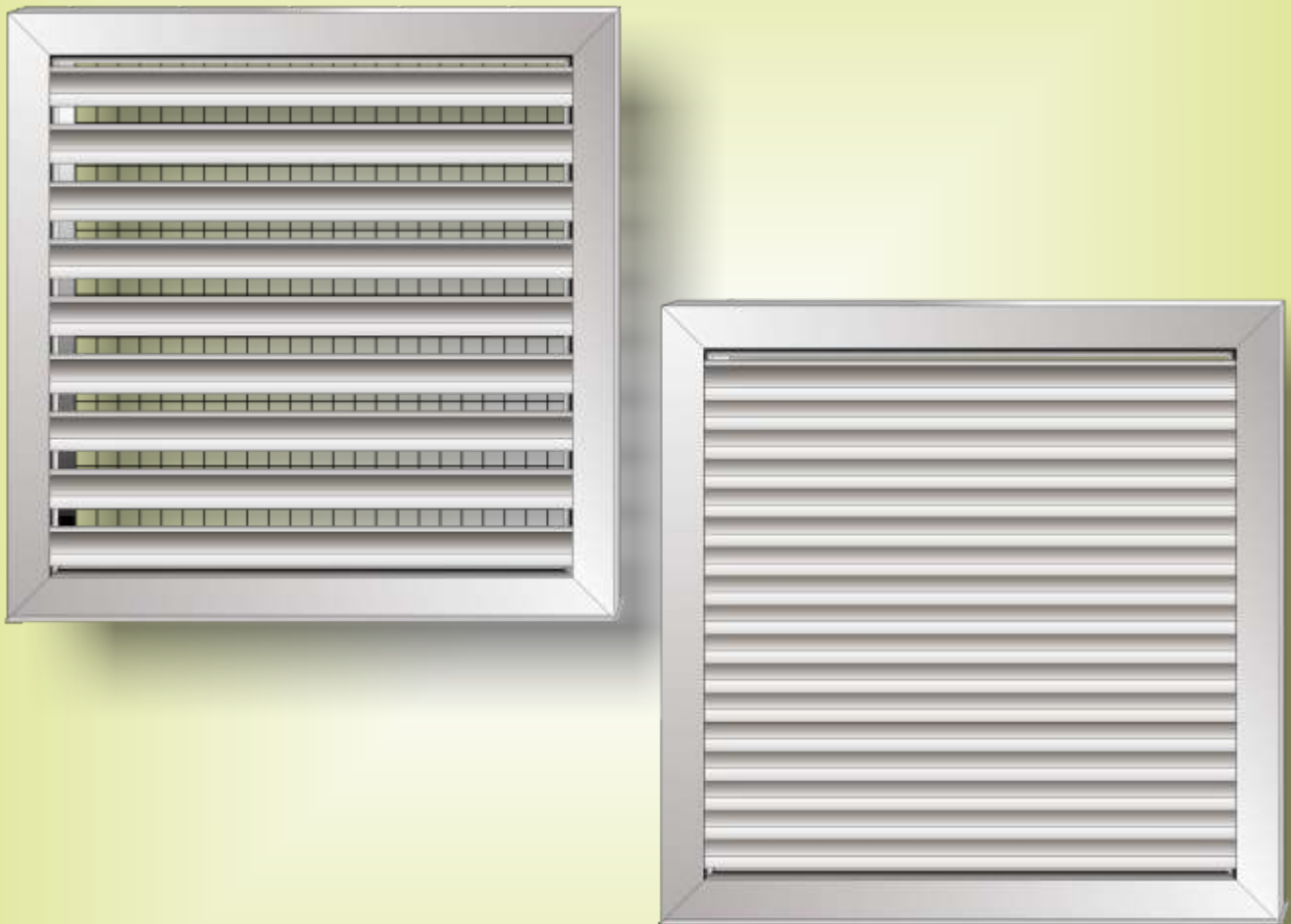



Ref. no.: 260 - 261

Weather resistant louver



-  Easy combination with our multi-leaf dampers JS/JL
-  Aluminium blades guarantee corrosion protection even in the area of the sharp edges
-  Low pressure loss due to minimum flow resistance of the blades
-  Frame in aluminium as extruded shape with double cheek and constant drip nose for the protection of the front

	AEROTECHNIK SIEGWART	Aerotechnik E. Siegwart GmbH Untere Hofwiesen • D-66299 Friedrichsthal  +49 (0) 6897/859-0 •  +49 (0) 6897/859-150 www.aerotechnik.de • info@aerotechnik.de
---	---------------------------------	---

Advantages and construction details

- Form:** Functional frame and blades made from aluminium, anodized (additional charge), colour can be chosen.
- Frame:** Made of extrusion profiles in aluminium, guaranteeing high corrosion protection and good fitting accuracy. In order to avoid nests of dirt and water, the lower frame profile is smoothbore and has a constant drip nose which covers the overall width.
Available without drip nose on request.
- Blades:** The blades are fixed to the aluminium section by means of a screw fastening and can be exchanged separately in case of damage.
Available with half blade division for special requirements.
- Protective grille:** Made from galvanized corrugated wire with clips fastening.
- Pressure loss:** Due to the minimum flow resistance of the blades and the protective grille, the pressure loss is extremely low.
- Installation and combination:** The frame profile enables a universal installation in façades, conditioners and ducts. The weather resistant louver can easily be combined with our multi-leaf dampers JS/JL by means of a connection frame or an extended multi-leaf damper frame.
- Accessories:** Mounting frame made of galvanized sheet steel 2 mm.
- Special version:** Single-leaf and multi-leaf door execution for roof conditioners.
- Specification text:** **Weather resistant louver WG, manufacturer AEROTECHNIK SIEGWART GmbH**, in aluminium execution. With smooth tray and drip nose covering the overall frame width, blade execution for low pressure loss.

Width "a" = _____ mm

Height "b" = _____ mm

Execution: _____

Accessories with / without mounting frame



**AEROTECHNIK
SIEGWART**

Aerotechnik E. Siegwart GmbH
Untere Hofwiesen • D-66299 Friedrichsthal
☎ + 49 (0) 6897/859-0 • 📠 +49 (0) 6897/859-150
www.aerotechnik.de • info@aerotechnik.de

Ref. no.: 260 - 261

Weather resistant louver



Ref. no.: 260

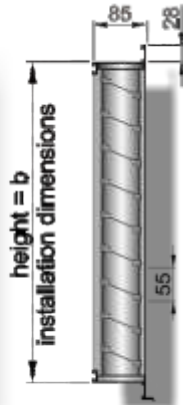

Ref. no.: 261

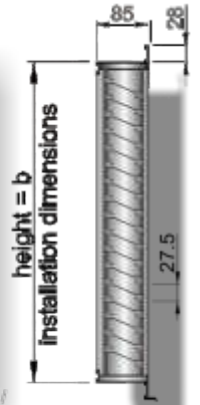

Prices		a = width [mm]												
		300	400	500	600	700	800	900	1000	1200	1400	1600	1800	2000
b = height [mm]	345	50,00 €	55,00 €	60,00 €	66,00 €	73,00 €	78,00 €	83,00 €	90,00 €	101,00 €	119,00 €	129,00 €	141,00 €	154,00 €
	510	63,00 €	70,00 €	78,00 €	85,00 €	93,00 €	100,00 €	108,00 €	116,00 €	130,00 €	152,00 €	166,00 €	182,00 €	192,00 €
	675	78,00 €	87,00 €	96,00 €	105,00 €	116,00 €	125,00 €	134,00 €	145,00 €	169,00 €	189,00 €	207,00 €	227,00 €	247,00 €
	840	92,00 €	103,00 €	113,00 €	124,00 €	137,00 €	148,00 €	159,00 €	171,00 €	199,00 €	222,00 €	244,00 €	268,00 €	292,00 €
	1005	107,00 €	119,00 €	132,00 €	144,00 €	160,00 €	172,00 €	185,00 €	200,00 €	232,00 €	260,00 €	285,00 €	313,00 €	341,00 €
	1170	120,00 €	135,00 €	149,00 €	162,00 €	181,00 €	195,00 €	209,00 €	227,00 €	261,00 €	293,00 €	322,00 €	353,00 €	385,00 €
	1335	135,00 €	151,00 €	168,00 €	184,00 €	204,00 €	220,00 €	236,00 €	256,00 €	294,00 €	330,00 €	362,00 €	398,00 €	434,00 €
	1500	149,00 €	167,00 €	185,00 €	203,00 €	224,00 €	242,00 €	260,00 €	282,00 €	324,00 €	363,00 €	400,00 €	439,00 €	478,00 €
	1665	164,00 €	184,00 €	203,00 €	223,00 €	247,00 €	267,00 €	287,00 €	311,00 €	357,00 €	401,00 €	440,00 €	483,00 €	528,00 €
	1830	177,00 €	199,00 €	220,00 €	242,00 €	268,00 €	290,00 €	311,00 €	337,00 €	386,00 €	434,00 €	477,00 €	525,00 €	572,00 €
1995	192,00 €	216,00 €	239,00 €	262,00 €	291,00 €	314,00 €	338,00 €	366,00 €	419,00 €	471,00 €	518,00 €	570,00 €	622,00 €	

All intermediate sizes available. The price of the next in size dimension is calculated.
For weather resistant louvers with a blade distance of 27,5 mm, the prices have to be multiplied by the factor 1,5.

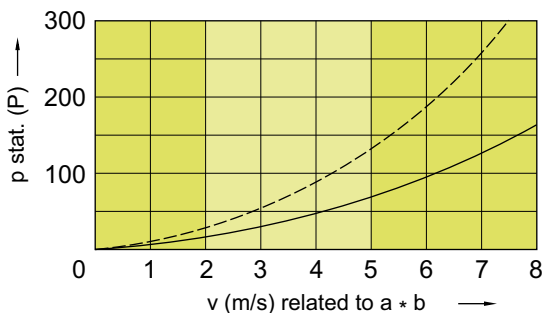

Pressure loss of the weather resistant louver

- blade division 55,0 mm (72% free cross section) ref. no. 260
- - - blade division 27,5 mm (50% free cross section) ref. no. 261

Recommended speed of aspiration 2 - 4 m/s

Order example

Quantity	ref. no.	width "a" [mm]	height "b" [mm]
15	260	800	840

In general:

Weather resistant louvers provide protection against rain and the ingressing of leaves and birds into induction and extract openings of ventilation systems. For physical reasons the passing through of low water quantities under the influence of diverse parameters can not be avoided. An approximate rainproofness is realizable in conjunction with secondary eliminators.

Price setting:

Our prices are quoted exclusive of VAT, without packaging, ex works. Our conditions of delivery and sale are valid. If necessary, the packaging is quoted at cost price.



Aerotechnik E. Siegwart GmbH
 Untere Hofwiesen • D-66299 Friedrichsthal
 ☎ + 49 (0) 6897/859-0 • 📠 +49 (0) 6897/859-150
 www.aerotechnik.de • info@aerotechnik.de

Ref. no.: 260 - 261

Weather resistant louver

Mounting
frame

Ref. no.: 265

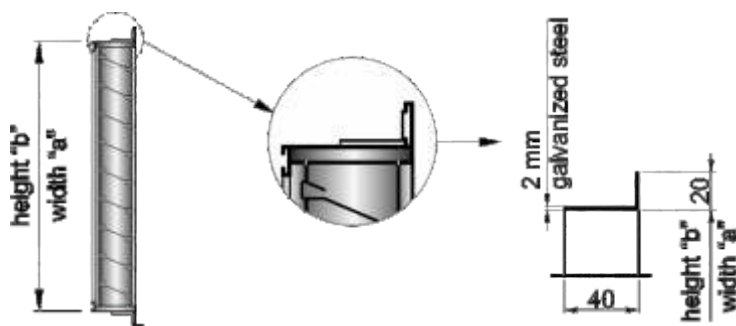

Prices	a = width [mm]													
	300	400	500	600	700	800	900	1000	1200	1400	1600	1800	2000	
b = height [mm]	345	14,00 €	15,00 €	16,00 €	17,00 €	18,00 €	18,00 €	19,00 €	20,00 €	22,00 €	24,00 €	26,00 €	28,00 €	30,00 €
	510	15,00 €	16,00 €	17,00 €	18,00 €	19,00 €	20,00 €	21,00 €	22,00 €	23,00 €	25,00 €	27,00 €	29,00 €	31,00 €
	675	16,00 €	17,00 €	18,00 €	19,00 €	20,00 €	21,00 €	22,00 €	23,00 €	25,00 €	27,00 €	29,00 €	30,00 €	32,00 €
	840	17,00 €	18,00 €	19,00 €	20,00 €	21,00 €	22,00 €	23,00 €	24,00 €	26,00 €	28,00 €	30,00 €	32,00 €	33,00 €
	1005	18,00 €	19,00 €	20,00 €	21,00 €	22,00 €	23,00 €	24,00 €	25,00 €	27,00 €	29,00 €	31,00 €	33,00 €	35,00 €
	1170	20,00 €	21,00 €	22,00 €	23,00 €	24,00 €	24,00 €	25,00 €	26,00 €	28,00 €	30,00 €	32,00 €	34,00 €	36,00 €
	1335	21,00 €	22,00 €	23,00 €	24,00 €	25,00 €	26,00 €	27,00 €	27,00 €	29,00 €	31,00 €	33,00 €	35,00 €	37,00 €
	1500	22,00 €	23,00 €	24,00 €	25,00 €	26,00 €	27,00 €	28,00 €	29,00 €	31,00 €	32,00 €	34,00 €	36,00 €	38,00 €
	1665	23,00 €	24,00 €	25,00 €	26,00 €	27,00 €	28,00 €	29,00 €	30,00 €	32,00 €	34,00 €	36,00 €	37,00 €	40,00 €
	1830	24,00 €	25,00 €	26,00 €	27,00 €	28,00 €	29,00 €	30,00 €	31,00 €	33,00 €	35,00 €	37,00 €	39,00 €	41,00 €
	1995	25,00 €	26,00 €	27,00 €	28,00 €	29,00 €	30,00 €	31,00 €	32,00 €	34,00 €	36,00 €	38,00 €	40,00 €	42,00 €

In case the mounting frame is made of hot-dip galvanized angle steel 40 x 20 x 4 mm, the prices of the mounting frame made of galvanized steel 2 mm have to be multiplied by the factor 1,7.

Weather resistant louver in divided execution

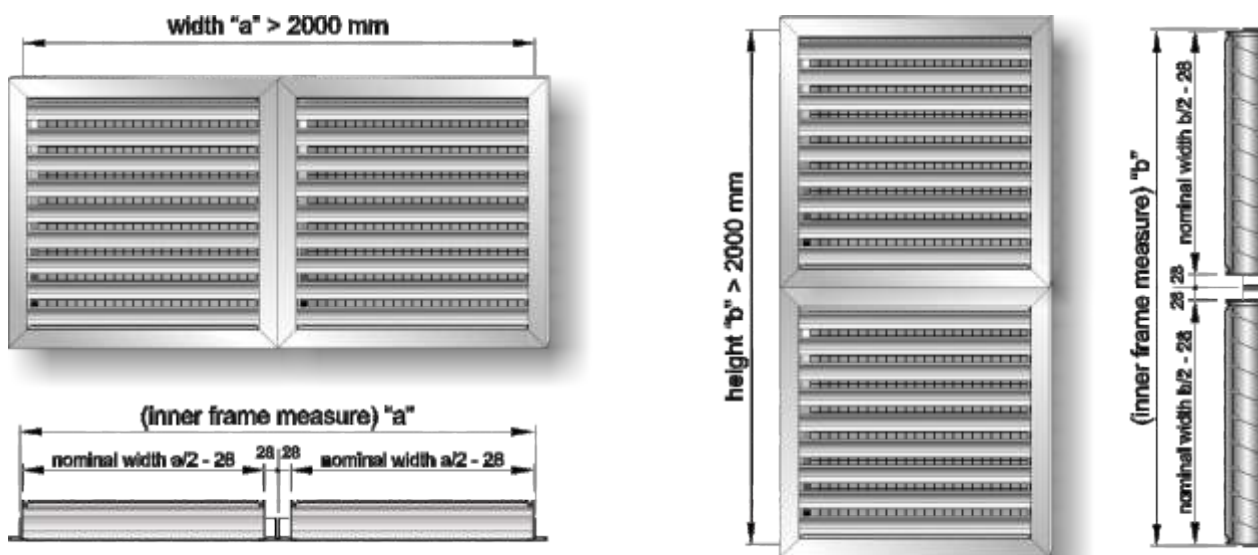

In case of installation without wall frame, a substructure for the conjunction of the two weather resistant louvers has to be provided by customer.



Aerotechnik E. Siegwart GmbH
 Untere Hofwiesen • D-66299 Friedrichsthal
 ☎ + 49 (0) 6897/859-0 • 📠 +49 (0) 6897/859-150
 www.aerotechnik.de • info@aerotechnik.de